

IMPORTANT:

Manufacturer is not responsible for negligent use of vehicle with mud flaps installed, including over-tightening of screws and bolts causing damage to vehicle or mud flaps.



TOOLS REQUIRED-



Phillips Screw Driver

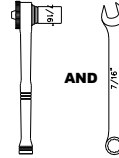

10mm Open Wrench and
Socket Wrench

FLAPS & BRACKETS

(1) Flap Assembly,
Front, DS
Part #766420

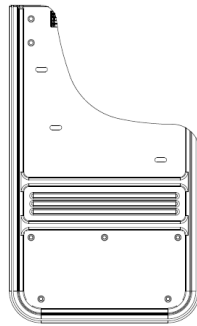

(1) Flap Assembly
Front, PS
Part #766421

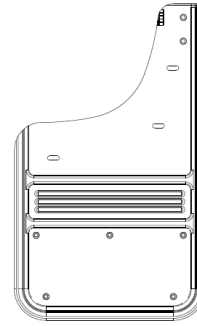

(2) Front Brace
Part #766412

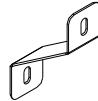

(2) Front Washer Plate
Part #766413

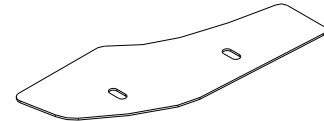

PARTS BAG # 766414

a) (4) Screw, Sht Metal
SS, #14-10 x 1-1/4"
Part #010047



b) (2) Screw, Mach.
SS, M6-35mm, Hex
Part #012028

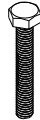

c) (10) Washer, Flat
0.281" x 1", SS
Part #018028

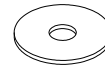

d) (2) Washer, Lock
18-8SS, 1/4"
Part #024000



e) (2) Nut, Hex
SS, M6-1
Part # 025022



g) (4) Washer, Nylon
1"OD x 0.318"ID x 0.04"
Part # 054061

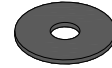

INSTALLATION *(For ease of installation it is suggested that the wheel be removed)*

1. Before you install your Mud Flap Set, see the diagram and parts list for all necessary parts.
2. Remove the factory splash guard by removing the (4) factory screws attaching it to the fender. Once removed, reinstall (1) factory screw located at the bottom of the fender.
3. Attach the brace onto the mud flap (front side) through holes #1 & #2 using (1) stainless steel hex bolt (#012028), (2) stainless steel washers (#018028), (1) stainless steel lock washers (#024000), and (1) stainless steel nut (#025022). See Diagram.
4. Loosely install mud flap and washer plate through holes #3 & #4 using (2) stainless steel screws (#010047), (2) stainless steel washers (#018028), and (2) nylon washers (#054061). **NOTE:** Nylon washers are used to help protect the aluminum washer plate from galvanic corrosion. See Diagram.
5. Attach the brace to the factory hole on inner wheel well through hole #5 using (1) factory screw and (1) stainless steel washer (#018028). See Diagram.
6. Using a bubble level or square, ensure that the mud flap is level. Viewing the truck from the back, the outer edge of the mud flap should appear parallel to the tires
7. Carefully tighten all fasteners (do not overtighten, as this can strip the factory plastic inserts), ensuring that the mud flap remains level.
8. Repeat procedure for the passenger side.

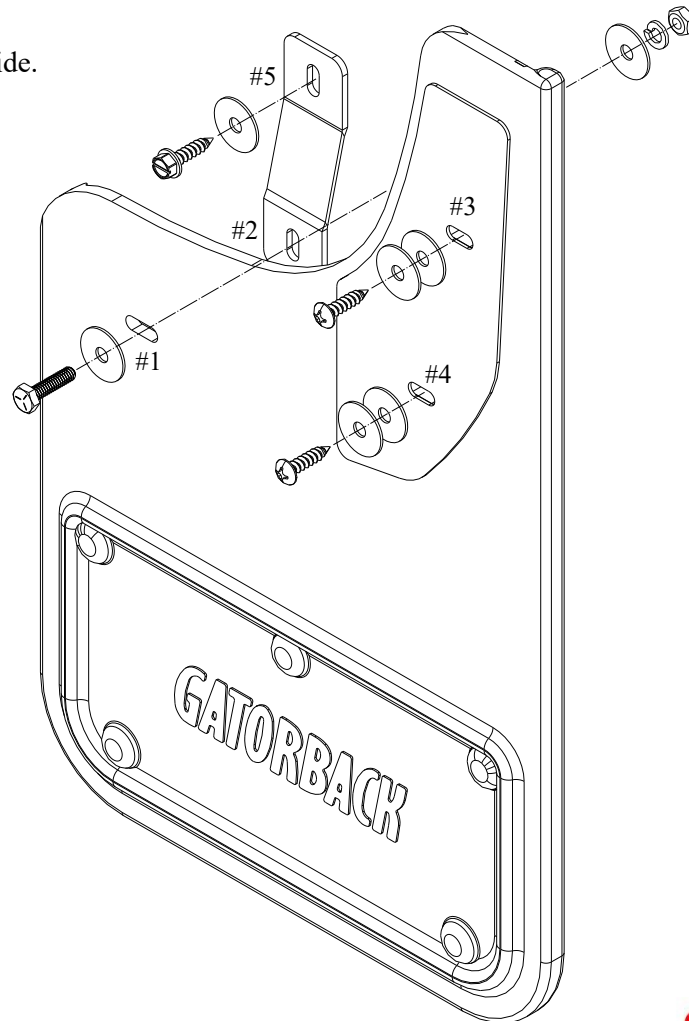

Please check out our YouTube channel to see an install video for this application.

